

# 36820-MS

## Multifunctional Stepper Motor Drive-Control Board

Multifunctional Stepper motor driver & control board for 2-phase 4-wire and 4-phase 5-wire stepper motors.

Reverse Polarity, Over Current & Temperature protected.

Input: for Limit switches.

Voltage Range: 5V-12VDC

Rated Current: 800mA

Step Rate: Jumper Select

Low Range: Each step takes 3.125 seconds-the fastest step takes 0.0625 seconds (16 steps/second).

High Range: each step requires 0.0625 seconds (16 steps/second)-the fastest step is 0.00125S (800 steps/second).

**4 operational Modes:** Jumper Select

**Normal 1:** Start and Stop button (alternate Action), Forward and Reverse button (Alternate Action), Potentiometer controls speed

**Normal 2:** Forward run button other button Reverse run. Press either button to stop. Potentiometer controls speed.

**Jog:** Press button to rotate forward, release to stop, Press other Button for reverse, release to stop, Potentiometer controls speed.

**Auto:** (Back & Forth) One Button Start and Stop, Other button Forward and Reverse, Potentiometer for speed, Second Potentiometer for automatic round-trip steps. After starting, the motor will automatically run back and forth within the steps adjusted by the pot.

Connections: 0.1" Pitch Header Pins.

**L:** 2-3/8" (Board) **W:** 1-3/4" **H:** 9/16" **WT:** .02

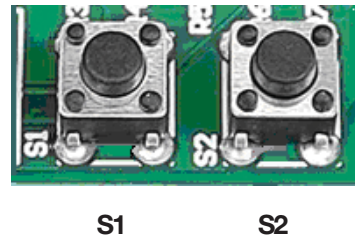
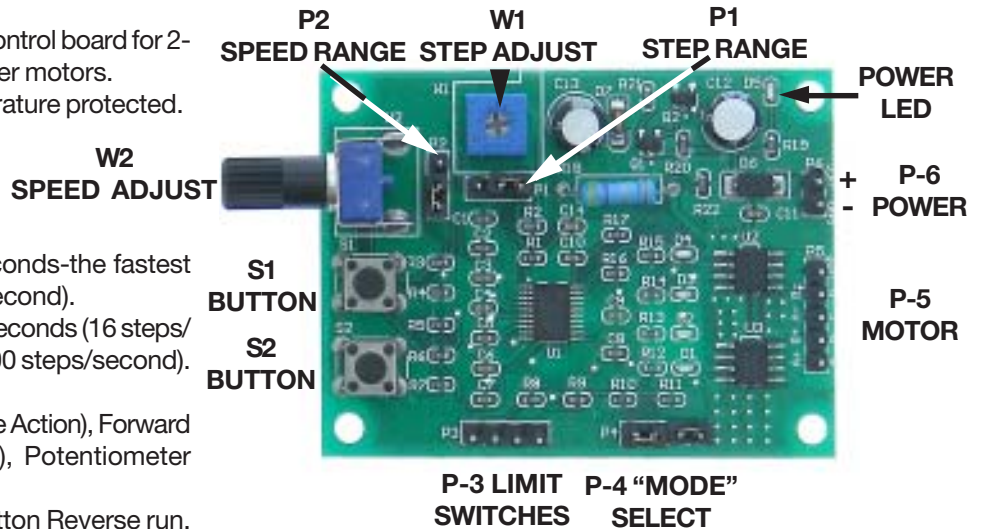

**Note 1:** **S1** and **S2** control buttons. The functions are different in each mode. For details, refer to the description of the **P4** function.

### Note 2:

When the load current exceeds 800mA, the circuit is protected, and the operation indicator flashes once every 2 seconds. At this time, it is necessary to reduce the operating voltage or replace the motor to work normally.

Information including Drawings, Schematics, Links and Code (Software) Supplied or Referenced in this Document is supplied by MPJA inc. as a service to our customers and accuracy or usefulness is not guaranteed nor is it an Endorsement of any particular part, supplier or manufacturer. Use of information and suitability for any application is at users own discretion and user assumes all risk.

Information Subject to Change Without Notice  
All rights are retained by the respective Owners/Author(s)

# 36820-MS

## Multifunctional Stepper Motor Drive-Control Board



**NORMAL  
MODE 1**



**NORMAL  
MODE 2**



**JOG MODE**

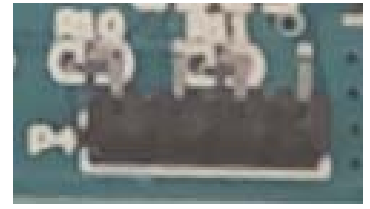

**AUTO MODE**

### P4 MODE Select:

**Normal Mode 1:** **S1** RUN/STOP Button , **S2** FORWARD/REVERSE Button, **W2** Potentiometer controls speed. If limit reverse is required, two Limit switches can be connected to the P3 Header, and the motor movement shaft is equipped with a contact piece, so that the motor will move back and forth within the stroke between the two limit switches.

**Normal Mode 2:** **S1** FORWARD Button, **S2** REVERSE Button, Press either key to stop. **W2** Potentiometer controls speed. If you need a limit stop, you can connect two Limit Switches to the P3 Header, so that the motor will stop moving when it touches the limit switch. Motor will reverse after you click the opposite button.

**Jog Mode:** Press **S1** to rotate FORWARD, Release to stop, Press **S2** press to REVERSE, Release to stop, **W2** Potentiometer controls speed. If you need a limit stop, you can connect an upper limit switch to P3 Header.

**Auto Cycle Mode:** **S1** RUN/STOP Button, **S2** FORWARD/REVERSE Button, **W2** Potentiometer controls speed. **W1** Potentiometer sets reciprocating steps. After starting, the motor will automatically run back and forth within the steps set by **W1/P1**.

### Note 3:

**1:** If you want to change any function pins of **P1**, **P2**, **P4**, you need to remove Power and then Power On again before the selected function takes effect.

Information including Drawings, Schematics, Links and Code (Software) Supplied or Referenced in this Document is supplied by MPJA inc. as a service to our customers and accuracy or usefulness is not guaranteed nor is it an Endorsement of any particular part, supplier or manufacturer. Use of information and suitability for any application is at users own discretion and user assumes all risk.

Information Subject to Change Without Notice  
All rights are retained by the respective Owners/Author(s)

# 36820-MS

## Multifunctional Stepper Motor Drive-Control Board

### W1 and P1 Stroke (#Steps) Control Function Description

**W1** Auto Reciprocating stroke adjustment potentiometer:  
Counterclockwise = Shorter stroke Clockwise = Longer stroke.

**P1** Reciprocating stroke adjustment range: Short-stroke: The adjustment range of **W1** is 1-200 steps.  
Long-stroke: the adjustment step range of **W1** is 200-1200 steps.



### W2 and P2 Speed Control Function Description

**W2** motor speed adjustment potentiometer:  
Counterclockwise = Slower, Clockwise = Faster.

**P2 Speed Range:** Set High/Low Speed Range

Range of **W2** in Slow is: Slowest step takes 3.125 seconds-the fastest step takes 0.0625 seconds (16 steps/second).

Range of **W2** in Fast is: Slowest step requires 0.0625 seconds (16 steps/second)-the fastest step is 0.00125S (800 steps/second).

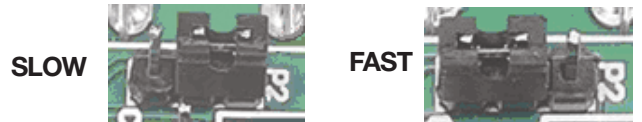

### P3 Limit Switch Function Description

Connections to External limit switch(es) are to the NO (Normally Open) and C (Common) terminals. Various sensors can be used, low level is sensed. Functions are different in each mode, refer to **P4** Function description for details.

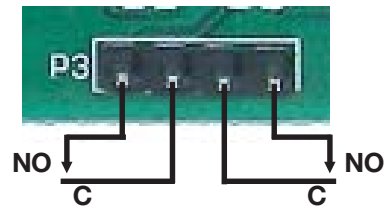

### P5 Stepper Motor Output Discription

Choice of 2-phase 4-wire or 4-phase 5-wire Step Motor, correctly connect the wires according to the letters on the board. To reverse Motor Rotation: switch either  $A/\bar{A}$  or  $B/\bar{B}$  (4Wire) or  $A/B$  or  $C/D$  (5 Wire)

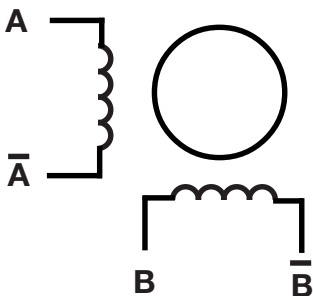

4 WIRE STEPPER

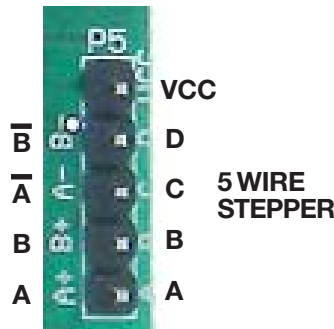

5 WIRE STEPPER

