

# DATA SHEET

## GENERAL PURPOSE CHIP RESISTORS

RC\_L series

$\pm 0.1\%$ ,  $\pm 0.5\%$ ,  $\pm 1\%$ ,  $\pm 5\%$

Sizes 0075/0100/0201/0402/0603/0805/  
1206/1210/1218/2010/2512

RoHS compliant & Halogen free



**SCOPE**

This specification describes RC series chip resistors with lead free terminations made by thick film process.

**APPLICATIONS**

- All general purpose application

**FEATURES**

- Halogen Free Epoxy
- RoHS compliant
  - Products with lead free terminations meet RoHS requirements
  - Pb-glass contained in electrodes, resistors element and glass are exempted by RoHS
- Reducing environmentally hazardous wastes
- High component and equipment reliability
- Saving of PCB space
- None forbidden-materials used in products/production

**ORDERING INFORMATION - GLOBAL PART NUMBER**

Global part numbers are identified by the series, size, tolerance, packing type, temperature coefficient, taping reel and resistance value.

**GLOBAL PART NUMBER**

**RC XXXX X X X XX XXXX L**  
 (1) (2) (3) (4) (5) (6) (7)

**(1) SIZE**

0075/0100/0201/0402/0603/0805/1206/1210/1218/2010/2512

**(2) TOLERANCE**

B = ±0.1%  
 D = ±0.5%  
 F = ±1.0%  
 J = ±5.0% (for jumper ordering, use code of J)

**(3) PACKAGING TYPE**

R = Paper taping reel  
 K = Embossed taping reel  
 S = ESD safe reel (0075/0100 only)

**(4) TEMPERATURE COEFFICIENT OF RESISTANCE**

- = Based on spec.

**(5) TAPING REEL**

07= 7 inch dia. Reel  
 10=10 inch dia. Reel  
 13=13 inch dia. Reel  
 7W = 7 inch dia. Reel & 2 x standard power  
 7N = 7 inch dia. Reel, ESD safe reel (0075/0100 only)

**(6) RESISTANCE VALUE**

There are 2~4 digits indicated the resistance value.  
 Letter R/K/M is decimal point  
 Example:  
 97R6 = 97.6Ω  
 9K76 = 9760Ω  
 1M = 1,000,000Ω

**(7) DEFAULT CODE**

Letter L is the system default code for ordering only.<sup>(Note)</sup>

**ORDERING EXAMPLE**

The ordering code for a RC0402 0.0625W chip resistor value 100KΩ with ±5% tolerance, supplied in 7-inch tape reel of 10,000 units per reel is: RC0402JR-07100KL.

**NOTE**

1. All our RSMD products meet RoHS compliant and Halogen Free. "LFP" of the internal 2D reel label mentions "Lead Free Process".
2. On customized label, "LFP" or specific symbol can be printed.

**MARKING**

RC0075 / RC0100 / RC0201 / RC0402



No Marking

RC0603

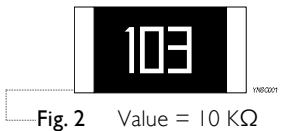

E24 series: 3 digits  
First two digits for significant figure and 3rd digit for number of zeros

RC0805 / RC1206 / RC1210 / RC2010 / RC2512

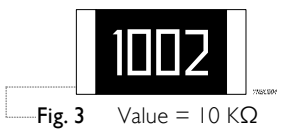

E24/E96 series: 4 digits  
First three digits for significant figure and 4th digit for number of zeros

RC1218

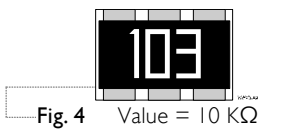

E-24 series: 3 digits, ±5%  
First two digits for significant figure and 3rd digit for number of zeros

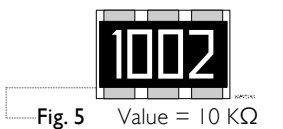

Both E-24 and E-96 series: 4 digits, ±1% & ±0.5%  
First three digits for significant figure and 4th digit for number of zeros

For further marking information, please see special data sheet "Chip resistors marking".

**CONSTRUCTION**

The resistor is constructed on top of a high-grade ceramic body. Internal metal electrodes are added on each end to make the contacts to the thick film resistive element. The composition of the resistive element is a noble metal imbedded into a glass and covered by a second glass to prevent environmental influences. The resistor is laser trimmed to the rated resistance value. The resistor is covered with a protective epoxy coat, finally the two external terminations (matte tin on Ni-barrier) are added, as shown in Fig.6.

**Outlines**

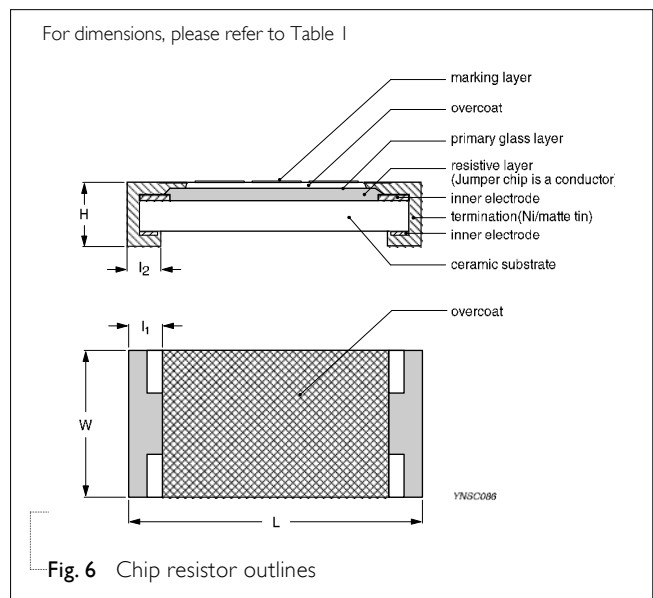

**DIMENSION**

Table 1

TYPE	L (mm)	W (mm)	H (mm)	l <sub>1</sub> (mm)	l <sub>2</sub> (mm)
RC0075	0.30±0.01	0.15±0.01	0.10±0.01	0.08±0.03	0.08±0.03
RC0100	0.40±0.02	0.20±0.02	0.13±0.02	0.10±0.03	0.10±0.03
RC0201	0.60±0.03	0.30±0.03	0.23±0.03	0.10±0.05	0.15±0.05
RC0402	1.00±0.05	0.50±0.05	0.35±0.05	0.20±0.10	0.25±0.10
RC0603	1.60±0.10	0.80±0.10	0.45±0.10	0.25±0.15	0.25±0.15
RC0805	2.00±0.10	1.25±0.10	0.50±0.10	0.35±0.20	0.35±0.20
RC1206	3.10±0.10	1.60±0.10	0.55±0.10	0.45±0.20	0.40±0.20
RC1210	3.10±0.10	2.60±0.15	0.50±0.10	0.45±0.15	0.50±0.20
RC1218	3.10±0.10	4.60±0.10	0.55±0.10	0.45±0.20	0.40±0.20
RC2010	5.00±0.10	2.50±0.15	0.55±0.10	0.45±0.15	0.50±0.20
RC2512	6.35±0.10	3.10±0.15	0.55±0.10	0.60±0.20	0.50±0.20

**ELECTRICAL CHARACTERISTICS**

Table 2

CHARACTERISTICS	POWER	OPERATING TEMPERATURE RANGE	MAXIMUM WORKING VOLTAGE	MAXIMUM OVERLOAD VOLTAGE	DIELECTRIC WITHSTANDING VOLTAGE	RESISTANCE RANGE	TEMPERATURE COEFFICIENT	JUMPER CRITERIA
RC0075	1/50 W	-55°C to 125°C	10V	25V	25V	5% (E24) 10Ω ≤ R ≤ 1MΩ 1% (E24/E96) 10Ω ≤ R ≤ 1MΩ Jumper < 50mΩ	10Ω ≤ R < 100Ω -200~+600ppm/°C 100Ω ≤ R ≤ 1MΩ ±200ppm/°C	Rated Current 0.5A Maximum Current 1.0A
RC0100	1/32 W	-55°C to 125°C	15V	30V	30V	5% (E24) 1Ω ≤ R ≤ 22MΩ 1% (E24/E96) 1Ω ≤ R ≤ 10MΩ 0.5% (E24/E96) 33Ω ≤ R ≤ 470KΩ Jumper < 50mΩ	1Ω ≤ R < 100Ω -200~+600ppm/°C 10Ω ≤ R < 100Ω: ±300ppm/°C 100Ω ≤ R ≤ 10MΩ: ±200ppm/°C 10MΩ < R ≤ 22MΩ: ±250ppm/°C	Rated Current 0.5A Maximum Current 1.0A
RC0201	1/20 W	-55°C to 125°C	25V	50V	50V	5% (E24) 1Ω ≤ R ≤ 10MΩ 1% (E24/E96) 1Ω ≤ R ≤ 10MΩ 0.1%, 0.5% (E24/E96) 10Ω ≤ R ≤ 1MΩ Jumper < 50mΩ	1Ω ≤ R ≤ 10Ω -100~+350ppm/°C 10Ω < R ≤ 10MΩ ±200ppm/°C	Rated Current 0.5A Maximum Current 1.0A

Table 2

CHARACTERISTICS	POWER	OPERATING TEMPERATURE RANGE	MAXIMUM WORKING VOLTAGE	MAXIMUM OVERLOAD VOLTAGE	DIELECTRIC WITHSTANDING VOLTAGE	RESISTANCE RANGE	TEMPERATURE COEFFICIENT	JUMPER CRITERIA
RC0402	1/16 W	-55°C to 155°C	50V	100V	100V	5% (E24) 1Ω≤R≤22MΩ 1% (E24/E96) 1Ω≤R≤10MΩ 0.1%, 0.5% (E24/E96) 10Ω≤R≤1MΩ Jumper<50mΩ	1Ω≤R≤10Ω ±200ppm°C 10Ω<R≤10MΩ ±100ppm°C 10MΩ<R≤22MΩ ±200ppm°C	Rated Current 1.0A Maximum Current 2.0A
	1/8W	-55°C to 155°C	50V	100V	100V	5% (E24) 1Ω≤R≤1MΩ 1% (E24/E96) 1Ω≤R≤1MΩ	1Ω≤R≤1MΩ ±200ppm°C	
RC0603	1/10 W	-55°C to 155°C	75V	150V	150V	5% (E24) 1Ω≤R≤22MΩ 1% (E24/E96) 1Ω≤R≤10MΩ 0.1%, 0.5% (E24/E96) 10Ω≤R≤1MΩ Jumper<50mΩ	1Ω≤R≤10Ω ±200ppm°C 10Ω<R≤10MΩ ±100ppm°C 10MΩ<R≤22MΩ ±200ppm°C	Rated Current 1.0A Maximum Current 2.0A
	1/5 W	-55°C to 155°C	75V	150V	150V	5% (E24) 1Ω≤R≤1MΩ 1% (E24/E96) 1Ω≤R≤1MΩ	1Ω≤R≤1MΩ ±200ppm°C	
RC0805	1/8 W	-55°C to 155°C	150V	300V	300V	5% (E24) 1Ω≤R≤100MΩ 1% (E24/E96) 1Ω≤R≤10MΩ 0.1%, 0.5% (E24/E96) 10Ω≤R≤1MΩ 10%, 20% (E24) 24MΩ≤R≤100MΩ Jumper<50mΩ	1Ω≤R≤10Ω ±200ppm°C 10Ω<R≤10MΩ ±100ppm°C 10MΩ<R≤22MΩ ±200ppm°C 24MΩ<R≤100MΩ ±300ppm°C	Rated Current 2.0A Maximum Current 5.0A
	1/4 W	-55°C to 155°C	150V	300V	300V	5% (E24) 1Ω≤R≤1MΩ 1% (E24/E96) 1Ω≤R≤1MΩ	1Ω≤R≤1MΩ ±200ppm°C	
RC1206	1/4 W	-55°C to 155°C	200V	400V	500V	5% (E24) 1Ω≤R≤100MΩ 1% (E24/E96) 1Ω≤R≤10MΩ 0.1%, 0.5% (E24/E96) 10Ω≤R≤1MΩ 10%, 20% (E24) 24MΩ≤R≤100MΩ Jumper<50mΩ	1Ω≤R≤10Ω ±200ppm°C 10Ω<R≤10MΩ ±100ppm°C 10MΩ<R≤22MΩ ±200ppm°C 24MΩ≤R≤100MΩ ±300ppm°C	Rated Current 2.0A Maximum Current 10.0A
	1/2 W	-55°C to 155°C	200V	400V	500V	5% (E24) 1Ω≤R≤1MΩ 1% (E24/E96) 1Ω≤R≤1MΩ	1Ω≤R≤1MΩ ±200ppm°C	

**FOOTPRINT AND SOLDERING PROFILES**

For recommended footprint and soldering profiles, please refer to data sheet “Chip resistors mounting”

Table 2

CHARACTERISTICS	POWER	OPERATING TEMPERATURE RANGE	MAXIMUM WORKING VOLTAGE	MAXIMUM OVERLOAD VOLTAGE	DIELECTRIC WITHSTANDING VOLTAGE	RESISTANCE RANGE	TEMPERATURE COEFFICIENT	JUMPER CRITERIA
RC1210	1/2 W	-55°C to 155°C	200V	500V	500V	5% (E24)	1Ω ≤ R ≤ 10Ω	Rated Current 2.0A Maximum Current 10.0A
						1Ω ≤ R ≤ 22MΩ	±200ppm°C	
						1% (E24/E96)	10Ω < R ≤ 10MΩ	
						1Ω ≤ R ≤ 10MΩ	±100ppm°C	
						0.1%, 0.5% (E24/E96)	10MΩ < R ≤ 22MΩ	
10Ω ≤ R ≤ 1MΩ	±200ppm°C							
Jumper < 50mΩ								
RC1218	1 W	-55°C to 155°C	200V	500V	500V	5% (E24)	1Ω ≤ R ≤ 10Ω	Rated Current 6.0A Maximum Current 10.0A
						1Ω ≤ R ≤ 1MΩ	±200ppm°C	
						1% (E24/E96)	10Ω < R ≤ 1MΩ	
						1Ω ≤ R ≤ 1MΩ	±100ppm°C	
						0.1%, 0.5% (E24/E96)		
10Ω ≤ R ≤ 1MΩ								
Jumper < 50mΩ								
RC2010	3/4 W	-55°C to 155°C	200V	500V	500V	5% (E24)	1Ω ≤ R ≤ 10Ω	Rated Current 2.0A Maximum Current 10.0A
						1Ω ≤ R ≤ 22MΩ	±200ppm°C	
						1% (E24/E96)	10Ω < R ≤ 10MΩ	
						1Ω ≤ R ≤ 10MΩ	±100ppm°C	
						0.1%, 0.5% (E24/E96)	10MΩ < R ≤ 22MΩ	
10Ω ≤ R ≤ 1MΩ	±200ppm°C							
Jumper < 50mΩ								
RC2512	1 W	-55°C to 155°C	200V	500V	500V	5% (E24)	1Ω ≤ R ≤ 10Ω	Rated Current 2.0A Maximum Current 10.0A
						1Ω ≤ R ≤ 22MΩ	±200ppm°C	
						1% (E24/E96)	10Ω < R ≤ 10MΩ	
						1Ω ≤ R ≤ 10MΩ	±100ppm°C	
						0.1%, 0.5% (E24/E96)	10MΩ < R ≤ 22MΩ	
10Ω ≤ R ≤ 1MΩ	±200ppm°C							
Jumper < 50mΩ								
	2 W	-55°C to 155°C	200V	400V	500V	5% (E24)	1Ω ≤ R ≤ 1MΩ	
						1Ω ≤ R ≤ 1MΩ	±200ppm°C	
						1% (E24/E96)		
						1Ω ≤ R ≤ 1MΩ		

**PACKING STYLE AND PACKAGING QUANTITY**

Table 3 Packing style and packaging quantity

PACKING STYLE	PAPER TAPING REEL (R)			ESD SAFE REEL (S) (4MM WIDTH, 1MM PITCH PLASTIC EMBOSSSED)	EMBOSSSED TAPING REEL
REEL DIMENSION	7" (178 mm)	10" (254mm)	13" (330 mm)	7" (178 mm)	7" (178 mm)
RC0075	---	---	---	20000	---
RC0100	20000	---	80000	40000	---
RC0201	10000	20000	50000	---	---
RC0402	10000	20000	50000	---	---
RC0603	5000	10000	20000	---	---
RC0805	5000	10000	20000	---	---
RC1206	5000	10000	20000	---	---
RC1210	5000	10000	20000	---	---
RC1218	---	---	---	---	4000
RC2010	---	---	---	---	4000
RC2512	---	---	---	---	4000

**NOTE**

For tape and reel specification/dimensions, please refer to data sheet "Chip resistors packing".

**FUNCTIONAL DESCRIPTION**

**OPERATING TEMPERATURE RANGE**

RC0402 to RC2512 Range: -55°C to +155°C (Fig. 7-1)

RC0075 to RC0201 Range: -55°C to +125°C (Fig. 7-2)

**POWER RATING**

Each type rated power at 70 °C:

- RC0075=1/50W
- RC0100=1/32W
- RC0201=1/20W
- RC0402=1/16W, 1/8W
- RC0603=1/10W, 1/5W
- RC0805=1/8W, 1/4W
- RC1206=1/4W, 1/2W
- RC1210=1/2W
- RC1218=1W
- RC2010=3/4W
- RC2512=1W, 2W

**RATED VOLTAGE**

The DC or AC (rms) continuous working voltage corresponding to the rated power is determined by the following formula:

$$V = \sqrt{(P \times R)}$$

or max. working voltage whichever is less

Where

V = Continuous rated DC or AC (rms) working voltage (V)

P = Rated power (W)

R = Resistance value (Ω)

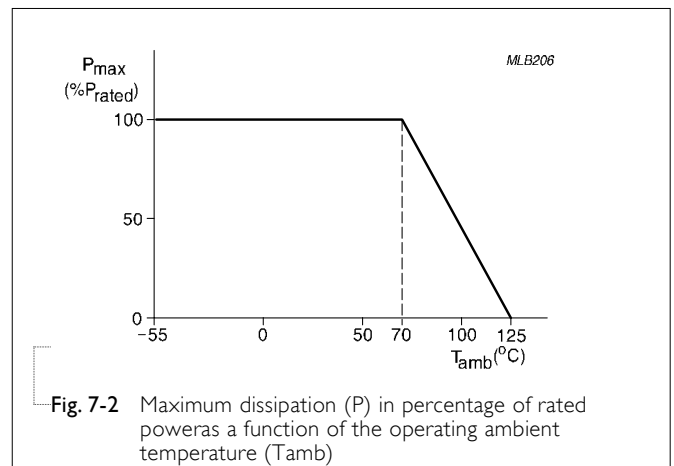
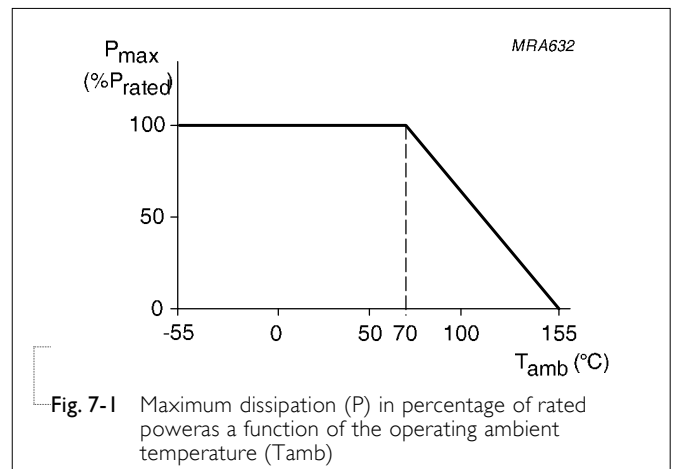

**TESTS AND REQUIREMENTS**

Table 8 Test condition, procedure and requirements

TEST	TEST METHOD	PROCEDURE	REQUIREMENTS
Temperature Coefficient of Resistance (T.C.R.)	MIL-STD-202 Method 304	At +25/-55 °C and +25/+125 °C  Formula: $T.C.R = \frac{R_2 - R_1}{R_1(t_2 - t_1)} \times 10^6 \text{ (ppm/°C)}$ Where t <sub>1</sub> =+25 °C or specified room temperature t <sub>2</sub> =-55 °C or +125 °C test temperature R <sub>1</sub> =resistance at reference temperature in ohms R <sub>2</sub> =resistance at test temperature in ohms	Refer to table 2
Life/ Endurance	MIL-STD-202 Method 108A IEC 60115-1 4.25.1	At 70±2°C for 1,000 hours; RCWV applied for 1.5 hours on and 0.5 hour off, still air required	0075: ± (5%+100mΩ) <100mΩ for jumper 01005: ±(3% +50mΩ ) < 100mΩ f or jumper Others: ±(1%+50mΩ) for B/D/F tol ±(3%+50mΩ) for J tol <100mR for jumper
High Temperature Exposure	MIL-STD-202 Method 108A IEC 60068-2-2	1,000 hours at maximum operating temperature depending on specification, unpowered.	0075: ± (5%+100mΩ) <100mΩ for jumper 01005: ±(1% +50mΩ) < 50mΩf or jumper Others: ±(1%+50mΩ) for B/D/F tol ±(2%+50mΩ) for J tol <50mR for jumper
Moisture Resistance	MIL-STD-202 Method 106G	Each temperature / humidity cycle is defined at 8 hours (method 106F), 3 cycles / 24 hours for 10d with 25 °C / 65 °C 95% R.H, without steps 7a & 7b, unpowered Parts mounted on test-boards, without condensation on parts	0075: ± (2%+100mΩ) <100mΩ for jumper 01005: ±(2% +50mΩ) < 100mΩf or jumper Others: ±(0.5%+50mΩ) for B/ D/F tol ±(2%+50mΩ) for J tol <100mR for jumper
Humidity	IEC 60115-1 4.24.2	Steady state for 1000 hours at 40 °C / 95% R.H. RCWV applied for 1.5 hours on and 0.5 hour off	0075: ± (5%+100mΩ) no visible damage 01005: ±(3% +50mΩ) < 100mΩf or jumper Others: ±(1%+50mΩ) for B/D/F tol ±(2%+50mΩ) for J tol <100mR for jumper

<b>Thermal Shock</b>	MIL-STD-202 Method 107G	-55/+125°C Note Number of cycles required is 300. Devices mounted Maximum transfer time is 20 seconds. Dwell time is 15 minutes. Air - Air	0075/01005: $\pm(1\% + 50m\Omega)$ < 50m $\Omega$ f or jumper Others: $\pm(0.5\% + 50m\Omega)$ for B/D/F tol $\pm(1\% + 50m\Omega)$ for J tol <50mR for jumper
<b>Short Time Overload</b>	IEC 60115-1 4.13	2.5 times RCWV or maximum overload voltage which is less for 5 seconds at room temperature	0075/01005: $\pm(2\% + 50m\Omega)$ < 50m $\Omega$ f or jumper Others: $\pm(1\% + 50m\Omega)$ for B/D/F tol $\pm(2\% + 50m\Omega)$ for J tol <50mR for jumper No visible damage
<b>Board Flex/Bending</b>	IEC 60115-1 4.33	Device mounted or as described only 1 board bending required bending time: 60 $\pm$ 5 seconds 0075/0100/0201/0402:5mm; 0603/0805:3mm; 1206 and above:2mm	0075/01005: $\pm(1\% + 50m\Omega)$ < 50m $\Omega$ f or jumper Others: $\pm(1\% + 50m\Omega)$ for B/D/F/J Tol <50mR for jumper No visible damage
<b>Solderability - Wetting</b>	J-STD-002 test B	Electrical Test not required Magnification 50X SMD conditions: 1st step: method B, aging 4 hours at 155 °C dry heat 2nd step: leadfree solder bath at 245 $\pm$ 3 °C Dipping time: 3 $\pm$ 0.5 seconds	Well tinned (>95% covered) No visible damage
<b>-Leaching</b>	J-STD-002 test D	Leadfree solder ,260°C, 30 seconds immersion time	No visible damage
<b>-Resistance to Soldering Heat</b>	MIL-STD-202 Method 210F IEC 60115-1 4.18	Condition B, no pre-heat of samples Leadfree solder, 260 °C $\pm$ 5°C, 10 $\pm$ 1 seconds immersion time Procedure 2 for SMD: devices fluxed and cleaned with isopropanol	0075: $\pm(3\% + 50m\Omega)$ <50m $\Omega$ for jumper 01005: $\pm(1\% + 50m\Omega)$ < 50m $\Omega$ f or jumper Others: $\pm(0.5\% + 50m\Omega)$ for B/D/F tol. $\pm(1\% + 50m\Omega)$ for J tol. <50mR for jumper No visible damage

**REVISION HISTORY**

REVISION	DATE	CHANGE NOTIFICATION	DESCRIPTION
Version 7	Mar. 7, 2017	-	- Add 10" packing
Version 6	Feb.15, 2017	-	- Extend RC0805 and RC1206 resistance range to 100Mohm
Version 5	Oct. 06, 2016	-	- Description: Update Dimension of I2 of RC2512 (2W)
Version 4	Jan. 22, 2016	-	- update resistance range
Version 3	Dec. 24, 2015	-	- Updated test and requirements
Version 2	Jul. 23, 2015	-	- Updated test and requirements
Version 1	Jan. 21, 2015	-	- ESD Safe Reel update
Version 0	Dec. 15, 2014	-	- First issue of this specification

*“Yageo reserves all the rights for revising the content of this datasheet without further notification, as long as the products itself are unchanged. Any product change will be announced by PCN.”*